

Lightweight Matte Boxes LMB 4x5



CONFIGURATION OVERVIEW – 8.2.3 / 2017.05

© 2010 Arnold & Richter Cine Technik GmbH & Co. Betriebs KG. All rights reserved. This material is provided "as is" for information purposes only without any warranty. ARRI assumes no responsibility with regard to the performance or use of the products or typographical errors or inaccuracies of given information. Product specifications are subject to change without notice. For a full listing of all available components consult the price list.

Sets for LMB 4x5

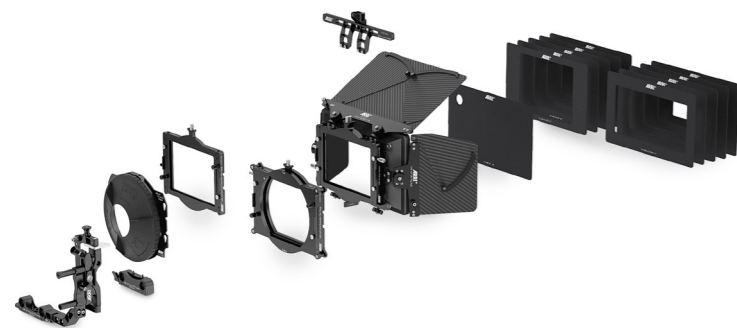

LMB 4x5 Pro Set
KK.0015177 - includes:
 K2.0007992 1x LMB-25 / MB-19 Set of Mattes anam.
 K2.0000069 1x LMB-25 Set of Mattes
 K2.0014206 1x LMB 4x5 Tilt and Flex Adapter
 K2.0013825 2x LMB 4x5 Flag Holders
 K2.0013750 1x LMB 4x5 Side Flags
 K2.0013724 1x LMB 4x5 Top Bottom Flag
 K2.0013447 1x LMB 4x5 Swing Away Tilt Module
 K2.0014006 1x LMB 4x5 Extra Non-Rotatable Filter Stage
 K2.0013460 1x LMB 4x5 Extra Rotatable Filter Stage
 K2.0013014 1x LMB Accessory Adapter
 K2.0013427 1x LMB 4x5 15 mm LWS Console
 K2.0013589 1x LMB 4x5 Basic Module (including tray catcher, filter frames and protection matte)
Note: Please order Studio Rod Adapters 15mm or 19mm separately



LMB 4x5 Clamp-On Set 3-stage
KK.0015175 - includes:
 K2.0013724 1x LMB 4x5 Top Bottom Flag
 K2.0014006 1x LMB 4x5 Extra Non-Rotatable Filter Stage
 K2.0013589 1x LMB 4x5 Basic Module (including tray catcher, filter frames and protection matte)
Note: Please order clamp adapters separately



LMB 4x5 15mm Lightweight Support (LWS) Set 3-stage
KK.0015176 - includes:
 K2.0013724 1x LMB 4x5 Top Bottom Flag
 K2.0014206 1x LMB 4x5 Tilt and Flex Adapter
 K2.0014006 1x LMB 4x5 Extra Non-Rotatable Filter Stage
 K2.0013427 1x LMB 4x5 15 mm LWS Console
 K2.0013589 1x LMB 4x5 Basic Module (including tray catcher, filter frames and protection matte)

Upgrade Set LMB-25 to LMB 4x5 basic

KK.0015178 - includes:
 K2.0015140 1x LMB 4x5 Backplate with Filter Guides (including protection matte)
 K2.0013825 1x LMB 4x5 Flag Holders

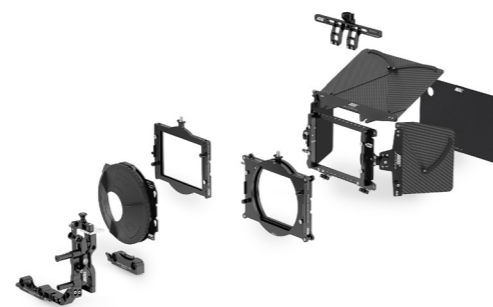

Upgrade Set LMB-25 to LMB 4x5 Pro

KK.0015181 - includes:
 K2.0015140 1x LMB 4x5 Backplate with Filter Guides (including protection matte)
 K2.0014206 1x LMB 4x5 Tilt and Flex Adapter
 K2.0013825 1x LMB 4x5 Flag Holders
 K2.0013750 1x LMB 4x5 Side Flags
 K2.0013724 2x LMB 4x5 Top Bottom Flag
 K2.0013447 1x LMB 4x5 Swing Away Tilt Module
 K2.0014006 1x LMB 4x5 Extra Non-Rotatable Filter Stage
 K2.0013460 1x LMB 4x5 Rotatable Filter Stage
 K2.0013014 1x LMB Accessory Adapter
 K2.0013427 1x LMB 4x5 15 mm LWS Console
Note: Please order Studio Rod Adapters 15mm or 19mm separately

LMB 4x5 Clamp Adapter Set

KK.0015133 - includes:
 K2.47243.0 1x LMB-25 Clamp Adapter Ø 80 mm
 K2.0015065 1x LMB 4x5 Clamp Adapter Ø 85mm
 K2.47242.0 1x LMB-25 Clamp Adapter Ø 87 mm
 K2.0014439 1x LMB 4x5 Clamp Adapter Ø 95mm
 K2.0015103 1x LMB 4x5 Clamp Adapter Ø 100mm
 K2.47253.0 1x LMB-25 Clamp Adapter Ø 104 mm
 K2.52097.0 1x LMB-25 Clamp Adapter Ø 110 mm
 K2.47240.0 1x LMB-25 Clamp Adapter Ø 114 mm
 K2.66219.0 1x LMB-25 Clamp Adapter Ø 125 mm
 K2.66217.0 1x LMB-25 Clamp Adapter Ø 134 mm
 K2.66218.0 1x LMB-25 Clamp Adapter Ø 136 mm
 K2.65223.0 1x LMB-25 Clamp Adapter Ø 143 mm (interface for LMB 4x5 15 mm LWS Console K2.0013427 integrated)
 K2.0015075 1x LMB 4x5 Clamp Adapter Ø 162mm



Clamp Adapter for LMB 4x5

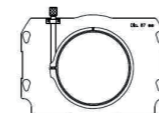

LMB 4x5 Clamp Adapter
 Ø 162mm, K2.0015075

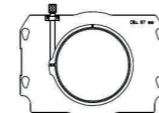

LMB 4x5 Clamp Adapter
 Ø 143 mm, K2.65223.0

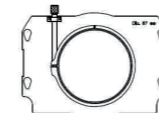

LMB 4x5 Clamp Adapter
 Ø 136 mm, K2.66218.0

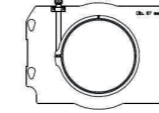

LMB 4x5 Clamp Adapter
 Ø 134 mm, K2.66217.0

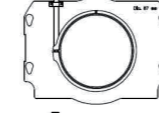

LMB 4x5 Clamp Adapter
 Ø 125 mm, K2.66219.0

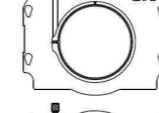

LMB 4x5 Clamp Adapter
 Ø 114 mm, K2.47240.0

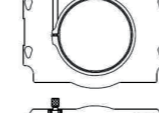

LMB 4x5 Clamp Adapter
 Ø 110 mm, K2.52097.0

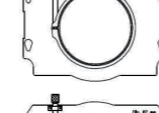

LMB 4x5 Clamp Adapter
 Ø 104 mm, K2.47253.0

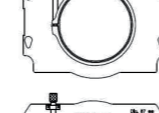

LMB 4x5 Clamp Adapter
 Ø 100 mm, K2.0015103

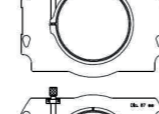

LMB 4x5 Clamp Adapter
 Ø 95 mm, K2.0014439

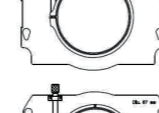

LMB 4x5 Clamp Adapter
 Ø 87 mm, K2.47242.0

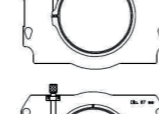

LMB 4x5 Clamp Adapter
 Ø 85 mm, K2.0015065



LMB 4x5 Clamp Adapter
 Ø 80 mm, K2.47243.0

CAUTION: RINGS CAN VIGNETTE. PLEASE CONTACT ARRI.

Accessories for LMB 4x5



LMB 4x5 Basic Module
 K2.0013589



LMB 4x5 Side Flags
 K2.0013750



LMB 4x5 Tilt and Flex Adapter, K2.0014206



LMB 4x5 Backplate with Filter Guides, K2.0015140



LMB 4x5 Rotatable Filter Stage, K2.0013460



LMB 4x5 Flag Holders
 K2.0013825



LMB 4x5 19 mm Studio Rod Adapter, K2.0013432



LMB 4x5 15 mm Studio Rod Adapter
 K2.0013440



LMB 4x5 15 mm LWS Console, K2.0013427



LMB 4x5 Swing Away Tilt Module
 K2.0013447



LMB 4x5 Extra Non-Rotatable Filter Stage
 K2.0014006



LMB 4x5 Top Bottom Flag, K2.0013724



Diopter Frame 138 mm
 K2.0013740



Diopter Adapter 138 mm to 4.5", K2.0014357



Diopter Stage 138mm
 K2.0014745

LMB 4x5 technical data:

Max number filters: up to three 4"x5.65" or 4"x4" filters

LMB 4x5 advanced features:

- One product covering a wide range of applications
- Clamp-on, 15mm lightweight and 15 and 19mm Studio Rod Support Options
- Offers quick and easy set up without tools
- Tilting option
- Safety gear such as a tray catcher and securing loop
- Accessory mount for ultrasonic or other devices
- Removable sunshade with captive screws

Ø = diameter of connection ring to lens